

EUHB-MMS

HB Microwave Motion Sensor



On/off control



Stand by period



Daylight On/off control



Detection area



Stand-by dimming level

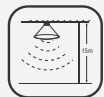

10-15M Highbay



Hold time



Remote control setting



5 years



Daylight sensor

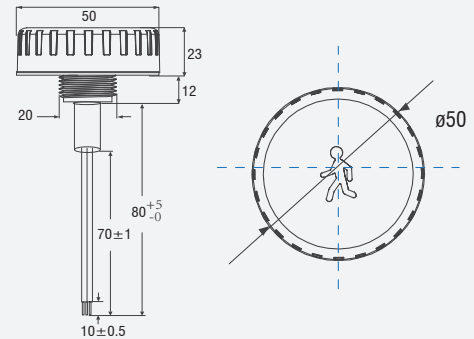

Technical Data

Unit:mm

Operating voltage	10-15V DC
Operating current	30mA±5%
Output	DIM 1-10V
Stand-by power	<0.5W
Detection area	25%/50%/75%/100%
Hold time	5s/30s/1min/3min//5min/10min/20min/30min
Daylight threshold	2Lux/10Lux/50Lux/80Lux/120Lux/Disable
IP rating	IP65

Stand-by period	0s/10s/30s/1min/5min/10min/30min/+∞
Stand-by dimming level	10%/20%/30%/50%
Microwave frequency	5.8GHz±75MHz
Microwave power	<0.3mW
Detection angle	30-150°
Mounting height	Max.15m(ceiling mounted)
Detection range	Max.ø14m(ceiling mounted)
Operating temperature	-20°C~+60°C

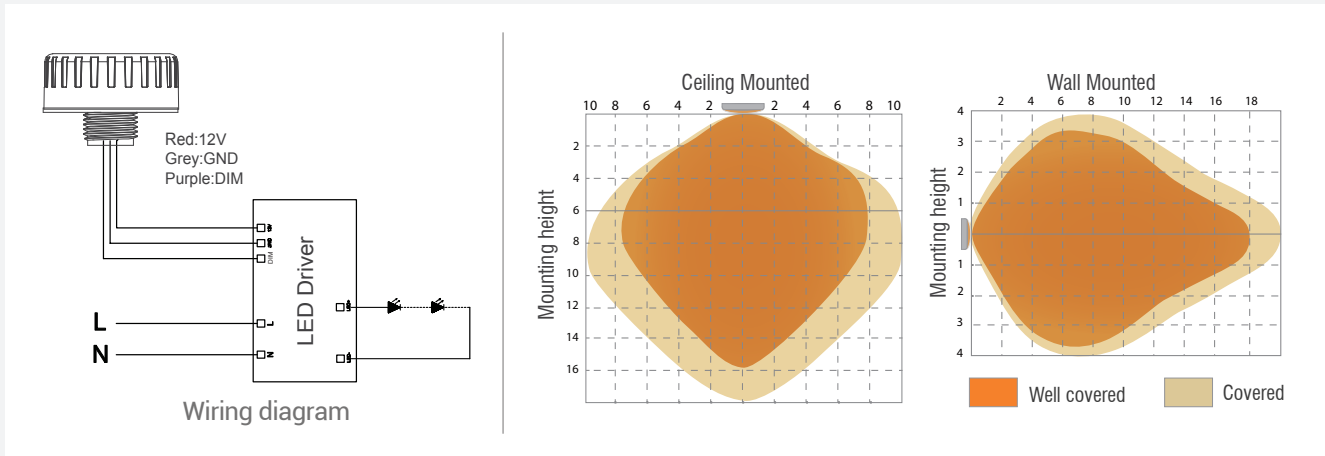

Lux on/off

Adopted dual PD technology, EUHB-MMS is able to differentiate artificial light brightness from natural light after installed inside the fixture, and automatically turn off light when ambient brightness exceeds preset lux level.

Preconditions to use the Lux-off function:

1. Standby period is $+\infty$;
2. Standby dimming level is on 10%, 20% or 30%;
3. Daylight threshold is on 30Lux, 50Lux, 80Lux or 120Lux.

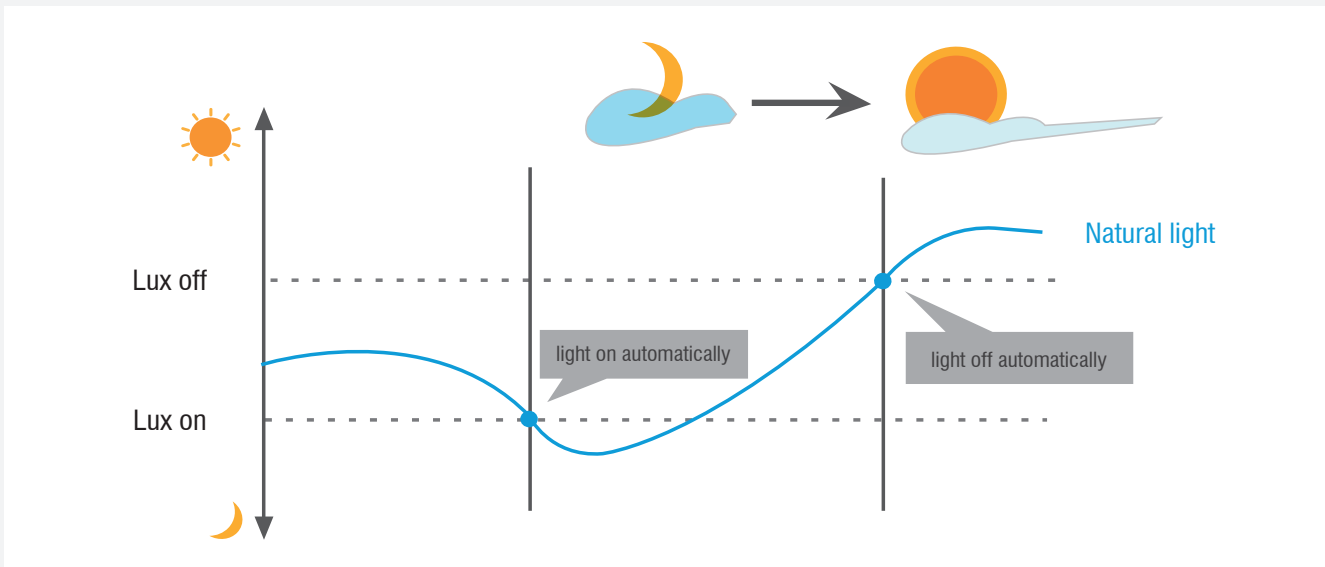

Application—Lux on/off

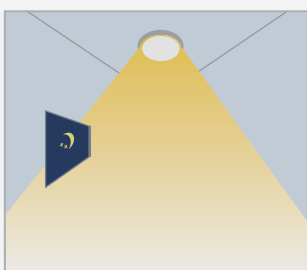

Light automatically on when ambient brightness is lower than preset lux level.



With insufficient ambient brightness, light dims to 100% when motion detected

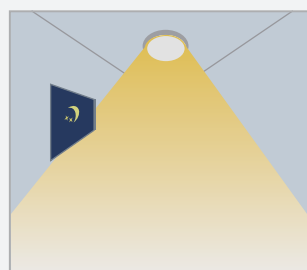

Light dims to standby level if no motion detected after holdtime

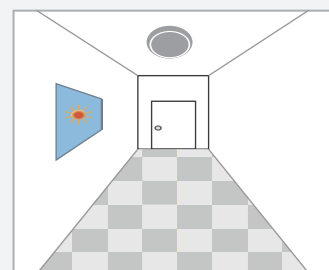

Light off when ambient lux level is higher than preset lux amount.